

# MiPosaur™



The Future of Prehistoric



## USER MANUAL

ITEM NO.: 0890 / 0891 / 0895



beaconsense™



gesturesense™



UCSD Coordinated  
Robotics Lab



# CONTENTS

<b>INTRODUCTION</b>	<b>P.2</b>
<b>BATTERY INFORMATION</b>	<b>P.3 - 4</b>
<b>MIPOSAUR™ OVERVIEW</b>	<b>P.5 - 6</b>
<b>GETTING STARTED</b>	<b>P.7</b>
<b>PERSONALITY &amp; MOODS</b>	<b>P.8</b>
CURIOUS MOOD	<b>P.8</b>
EXCITED MOOD	<b>P.9</b>
ANNOYED MOOD	<b>P.10</b>
<b>TRACKBALL</b>	<b>P.11</b>
<b>TRACKBALL AND APP</b>	<b>P.12</b>
<b>Q &amp; A</b>	<b>P.13</b>
<b>WARRANTY</b>	<b>P.14</b>



# INTRODUCTION

Thank you for purchasing Miposaur™ by WowWee®!

Meet Miposaur™, your new gesture tracking, self-balancing robotic creature! Out of the box, this intelligent robotic creature has an impressive blend of character and technology. Miposaur™ has an incredible evolving intelligence and personality, and an ability to sense its own surroundings and environment. Interact with Miposaur™ and it will respond in a unique and lifelike way! Take control, interact, and play with Miposaur™ in many ways; through Gesture Sense™ technology, use Beacon Sense™ via the Trackball, or a Bluetooth® Low Energy (BLE) enabled mobile device.

Take a few minutes to look through this user manual and get Miposaur™ ready to go.

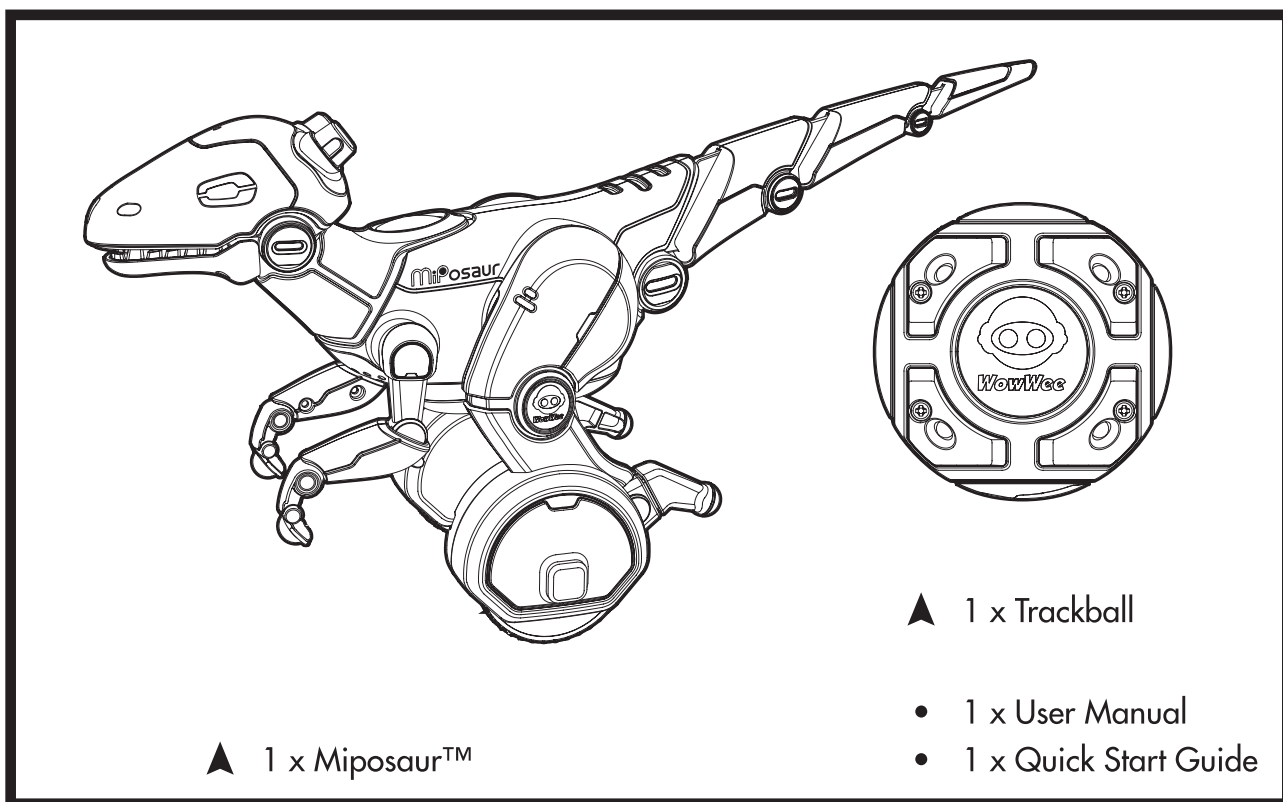

## Please note the following when operating Miposaur™:

- Do not immerse Miposaur™ or any parts in water or any other form of liquid.
- Do not drop, throw, or kick Miposaur™ as this may damage mechanical functions.
- Do not allow the robot to roam freely or leave unattended near edges from which Miposaur™ could fall.
- Miposaur™ is intended for indoor use only.



# BATTERY INFORMATION

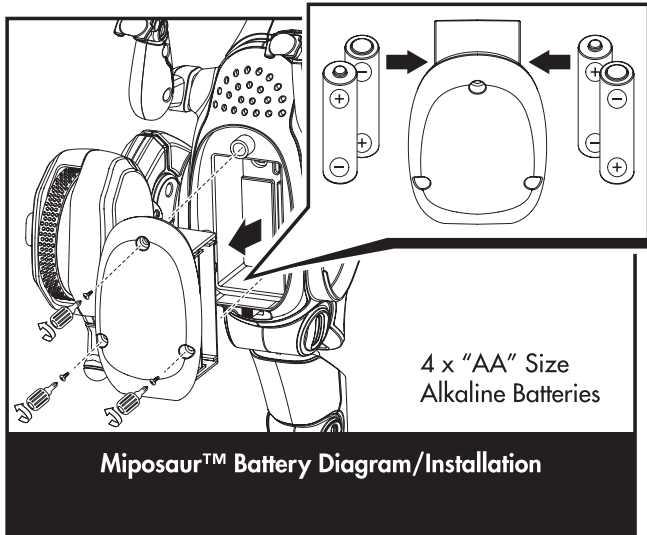

## Installing or changing batteries in Miposaur™:

1. To change the batteries, carefully lay Miposaur™ on its side. Miposaur™ requires 4 x "AA" size alkaline batteries (not included).
2. Using a Phillips screwdriver (not included) remove the screws on the battery compartment cover located on the bottom of the robot.
3. Insert the batteries according to the diagram. Ensure that the positive and negative polarities match the illustrations inside the battery compartment.
4. Replace the battery compartment cover and tighten screws using the screwdriver. Do not over-tighten.

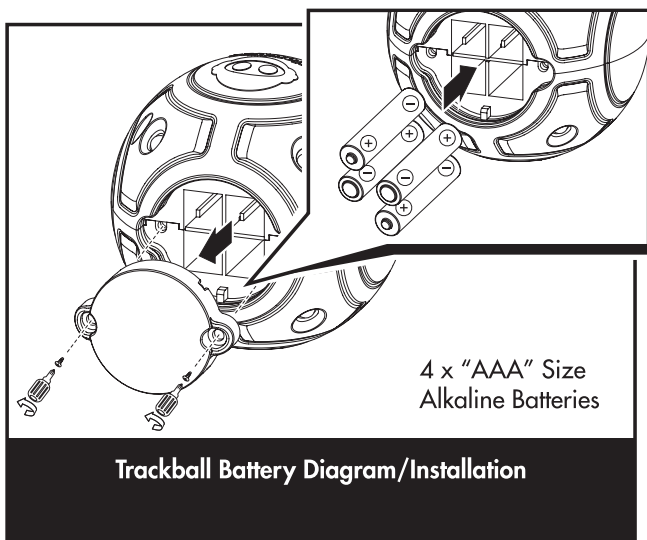

## Installing or changing batteries in the Trackball:

1. Lay the Trackball so that the battery compartment faces upwards. The Trackball requires 4 x "AAA" size alkaline batteries (not included).
2. Using a Phillips screwdriver (not included) remove the screws on the battery compartment cover located on the back of the ball.
3. Insert the batteries according to the diagram. Ensure that the positive and negative polarities match the illustrations inside the battery compartment.
4. Replace the battery compartment cover and tighten screws using the screwdriver. Do not over-tighten.



## LOW BATTERY INDICATORS:

When the batteries grow weak, Miposaur™ will move very slowly and easily fall down while moving or turning. When this occurs, power OFF and replace all batteries. When the batteries for the Trackball are low, the LED Power Indicator will not light up. When this occurs, power OFF and replace all batteries.

**NOTE:** You will know when Miposaur™'s batteries are nearly depleted because it will make a low battery indication sound and then power off. You can also see current battery levels via the Miposaur™ App.

## IMPORTANT BATTERY INFORMATION:

- Use only fresh batteries of the required size and recommended type.
- Do not mix old and new batteries, different types of batteries [standard (Carbon-Zinc), Alkaline or rechargeable] or rechargeable batteries of different capacities.
- Remove rechargeable batteries from the toy before recharging them.
- Rechargeable batteries are only to be charged under adult supervision.
- Please respect the correct polarity, (+) and (-).
- Do not try to recharge non-rechargeable batteries.
- Do not dispose of batteries into fire.
- Replace all batteries of the same type/brand at the same time.
- The supply terminals are not to be short-circuited.
- Remove exhausted batteries from the toy.
- Batteries should be replaced by adults.
- Remove batteries if the toy is not going to be played with for some time.
- Battery should be recycled or disposed of as per state and local guidelines.
- Protect the environment by not disposing of this product with household waste. Check your local authority for recycling advice and facilities.





# MIPOSAUR™ OVERVIEW

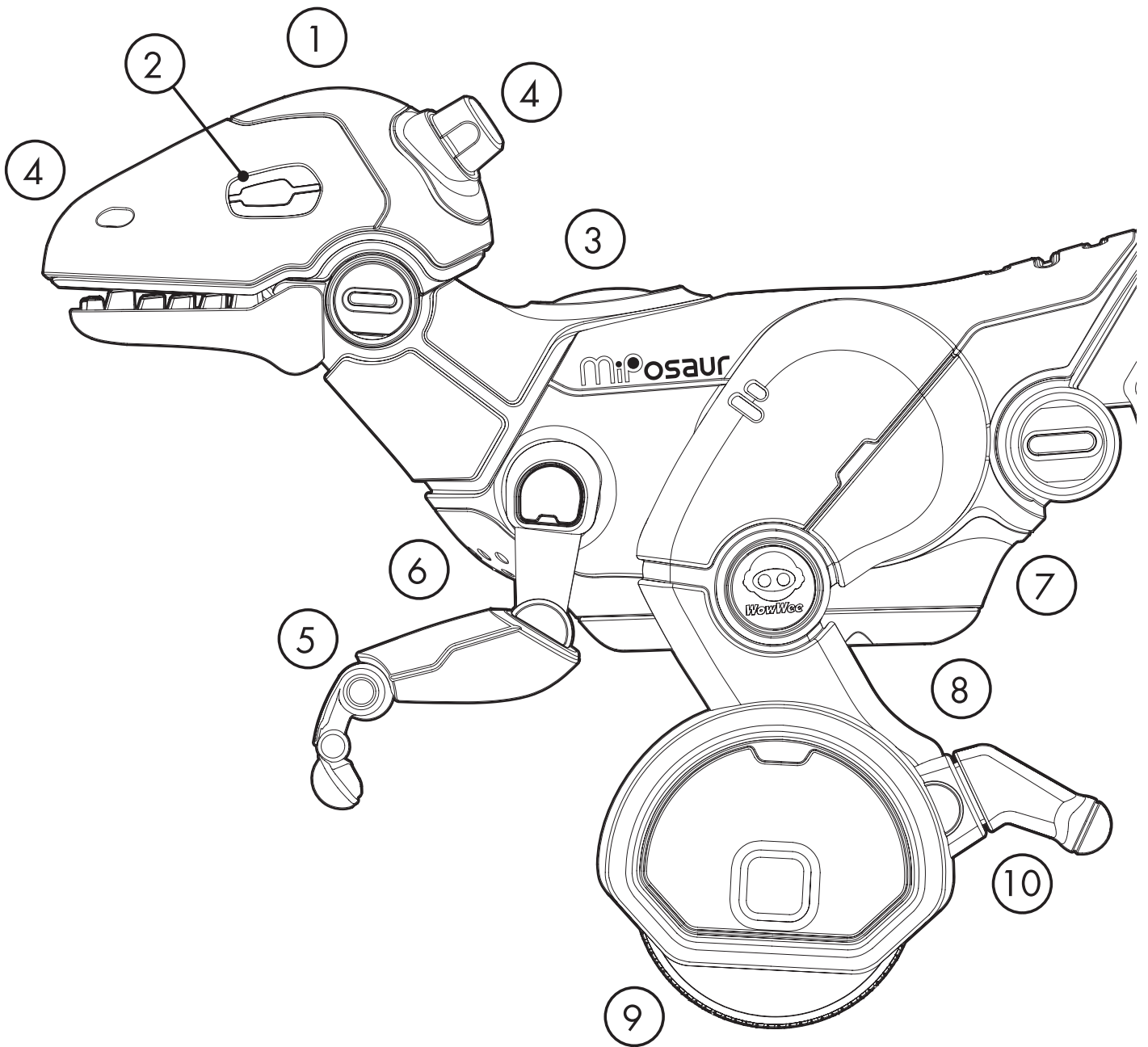

## MIPOSAUR™

1. Microphone
2. LED Eyes
3. LED Mood Indicator
4. IR Sensors
5. Arms
6. Speaker
7. ON/OFF Switch
8. Battery Compartment
9. Wheels
10. Heel
11. Tail

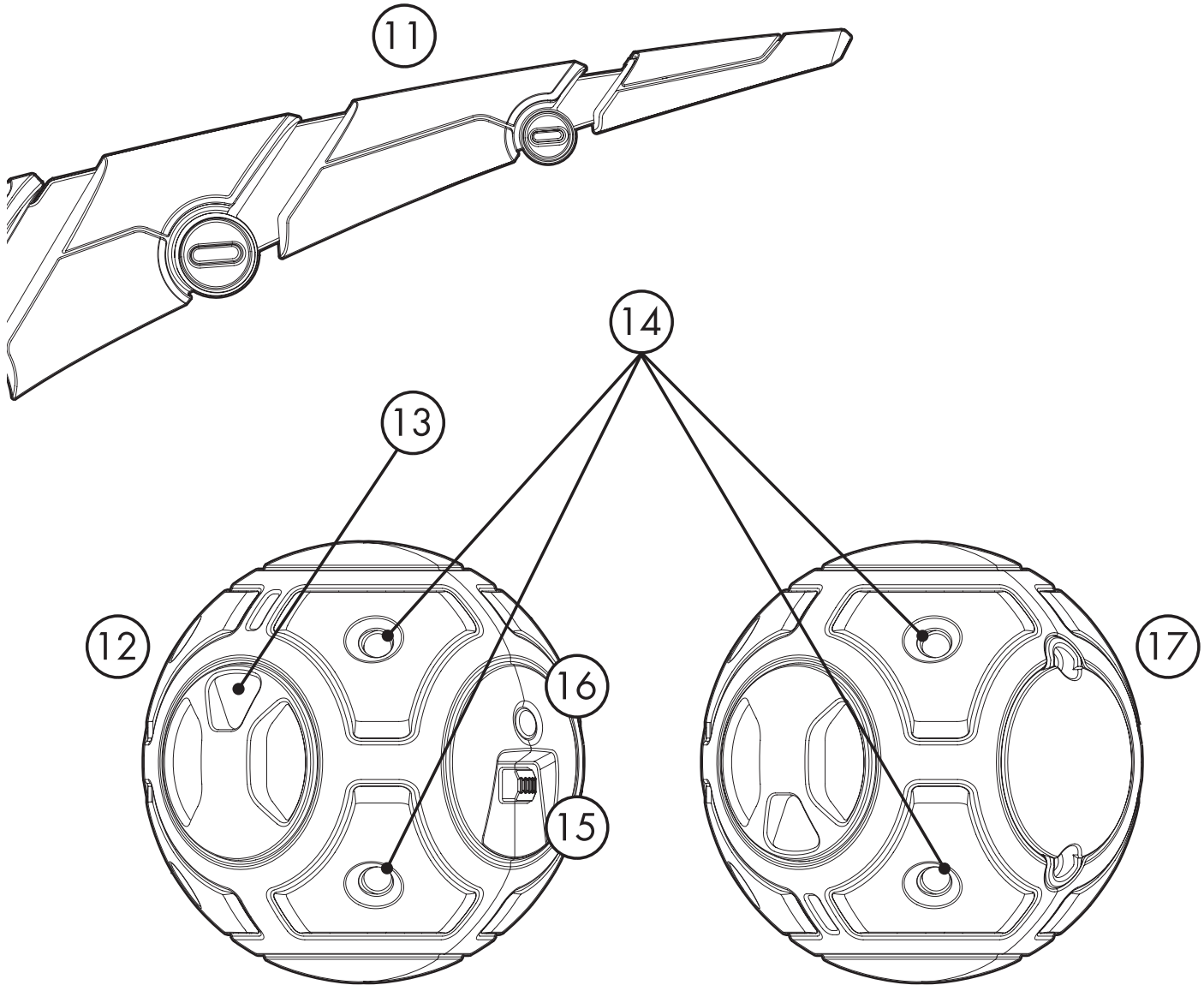

## TRACKBALL

- 12. Item Selection Wheel
- 13. Item Selection Window
- 14. Beacon Sense™ Array
- 15. ON/OFF Switch
- 16. LED Power Indicator
- 17. Battery Compartment



# GETTING STARTED

(1) With the batteries inserted, locate the power switch underneath the tail and activate Miposaur™ by toggling it to ON.

(2) Place Miposaur™ upright on its wheels on a flat and smooth surface, away from edges and obstacles. On successful balancing, you should feel traction in its wheels. At this point, let go and Miposaur™ will stand on its own with slight movements to correct its balance.

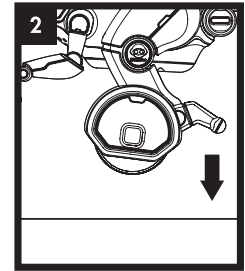
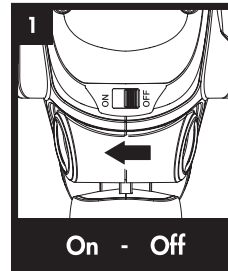

Miposaur™ can respond to various hand gestures and clapping and will react differently depending on its current mood (see pg 8-10). After Miposaur™ is balancing, you can use the actions below to interact with Miposaur™.

## BASIC COMMANDS

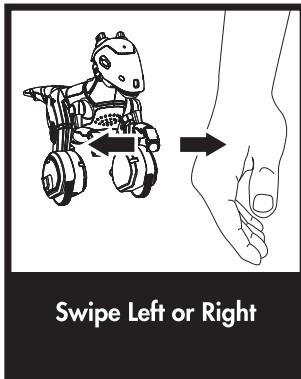

Swipe Left or Right

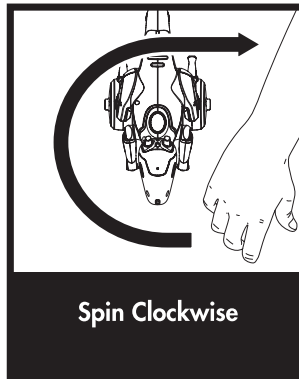

Spin Clockwise

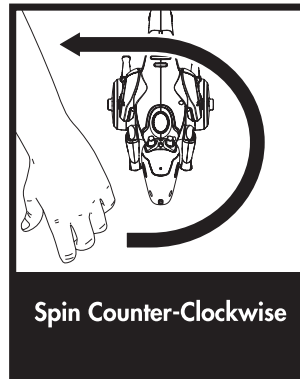

Spin Counter-Clockwise

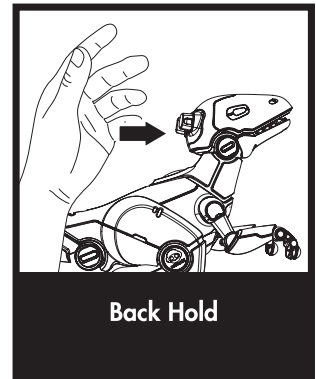

Back Hold

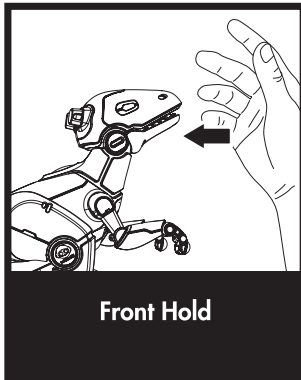

Front Hold

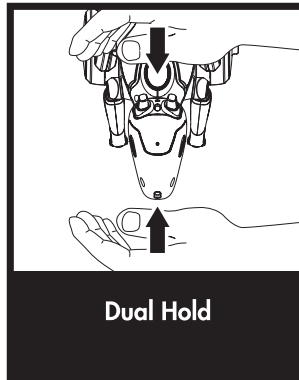

Dual Hold

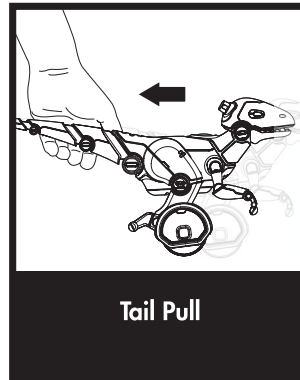

Tail Pull

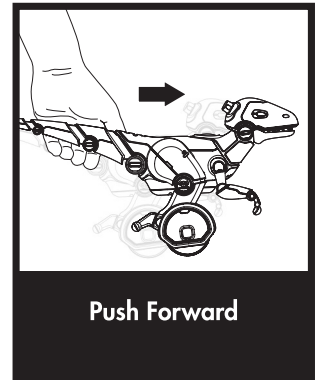

Push Forward

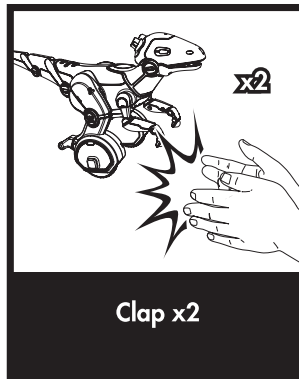

Clap x2



Clap x3





# PERSONALITY & MOODS

Curious mood

## MOODS

Depending on how you play and interact with Miposaur™, its personality will develop and mood will change. Various commands will affect Miposaur™ in different ways depending on its current mood and whether Miposaur™ is standing up, leaning back, or leaning forward.

### Curious Mood (default)

When Miposaur™ is first activated, it will be in its default Curious Mood, indicated by the BLUE color on the LED Mood Indicator. In this mood, Miposaur™ is neither annoyed nor excited. Below are the various commands that you can give to Miposaur™ to see its reaction. If you give Miposaur™ enough happy commands, it will start to get into an Excited Mood. However, if you give it too many unhappy commands, Miposaur™ will become upset and be in an Annoyed Mood.

	Command	Action
Standing Up	Swipe Left/Right	Turn Left or Right
	Spin Clockwise	Spin once clockwise
	Spin C-Clockwise	Spin once counter-clockwise
	Dual Hold	Muffled bark
	Back Hold	Fall forwards
	Front Hold	Fall backwards
	Tail Pull	Make grumpy noises
	Push Forwards	Make grumpy noises
	Clap x2	Sit backwards
	Clap x3	Roam around
Leaning Back	Front Hold	Track hand and pant
	Back Hold	Purr
	Clap x2	Get back up
	Clap x3	Get back up and roam around
Leaning Forwards	Front Hold	Track hand and pant
	Back Hold	Purr
	Clap x2	Get back up
	Clap x3	Get back up and roam around

**NOTE:** After inputting a command, the LED Mood Indicator on Miposaur™ will blink. Depending on Miposaur™'s current emotional state and the type of command given, the colour indicated will range between ORANGE - Excited Mood; BLUE - Curious Mood; and RED - Annoyed Mood.

A HAPPY command will shift Miposaur™'s emotional state towards the ORANGE end of the spectrum.  
 A NEUTRAL command will shift Miposaur™'s emotional state towards the BLUE, middle of the spectrum.  
 A UNHAPPY command will shift Miposaur™'s emotional state towards the RED end of the spectrum.

After inputting x5 of the same type of mood commands in a row, Miposaur™ will shift into the corresponding mood. After remaining idle for 30 seconds, Miposaur™ will revert back to its Curious Mood.



# PERSONALITY & MOODS

## Excited mood

### Excited Mood

When Miposaur™ has performed enough positive actions, it will be in an Excited Mood, which is indicated by the Orange colour on the LED Mood Indicator. When Miposaur™ is in this mood, it will make more happy sounds and actions when you give it commands.

	Command	Action
Standing Up	Swipe Left/Right	Turn Left or Right
	Spin Clockwise	Spin once clockwise
	Spin C-Clockwise	Spin once counter-clockwise
	Dual Hold	Muffled bark
	Back Hold	Fall forwards
	Front Hold	Fall backwards
	Tail Pull	Makes grumpy noise
	Push Forwards	Makes grumpy noise
	Clap x2	Sit backwards
	Clap x3	Roam around happily
Leaning Back	Front Hold	Track hand and bark
	Back Hold	Purr
	Clap x2	Get back up
	Clap x3	Get back up and roam around
Leaning Forwards	Front Hold	Track hand and bark
	Back Hold	Purr
	Clap x2	Get back up
	Clap x3	Get back up and roam around



# PERSONALITY & MOODS

## Annoyed mood

### Annoyed Mood

After receiving too many negative commands, Miposaur™ will start to make more unhappy sounds and actions. This means Miposaur™ is in an Annoyed Mood, and the LED Mood Indicator will become Red.

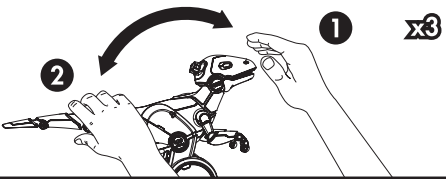
	Command	Action
Standing Up	Swipe Left/Right	Turn angrily left or right
	Spin Clockwise	Turn angrily left or right
	Spin C-Clockwise	Turn angrily left or right
	Dual Hold	Growl
	Back Hold	Spin around and growl
	Front Hold	Makes a grumpy noise and sits down
	Tail Pull	Makes a grumpy sound
	Push Forwards	Spin around and growl
	Clap x2	Sit down
	Clap x3	Roam around in an annoyed mood
Leaning Back	Front Hold	Track hand and growl
	Back Hold	Spin around and growl
	Clap x2	Get back up and growl
	Clap x3	Get back up and roam around in an annoyed mood
	Swipe x3	<b>SPECIAL: Calm Miposaur™</b> 
Leaning Forwards	Front Hold	Track hand and growl
	Back Hold	Spin around and growl
	Clap x2	Get back up and growl
	Clap x3	Get back up and roam around in an annoyed mood

### SLEEP MODE

After 20 minutes of inactivity, Miposaur™ will enter into Sleep Mode to conserve power. This is indicated by Miposaur™ falling either forwards or backwards, making a sound, and then powering down the LEDs.

To exit Sleep Mode, simply flip the power switch on the bottom to the Off position, and then back to the On position.



# TRACKBALL

## TRACKBALL

Miposaur™ comes with its favorite toy, the Trackball! By activating a different item on the Item Selection Wheel, you can activate different games and activities for you to play with Miposaur™. Miposaur™ even knows when the Trackball is close or far away, and it can even see when the Trackball is being shaken.

## Using the Trackball

- (1) With the batteries inserted, locate the power switch on the Trackball and turn it to the ON position.
- (2) Hold the Trackball as indicated and make sure not to cover the Beacon Sense™ sensors.
- (3) To activate different items, turn the Item Selection Wheel so that the desired toy icon is shown in the Item Selection Window. The LED Mood Indicator on Miposaur™'s back will change color, indicating a new item activation. See below for the various Items.

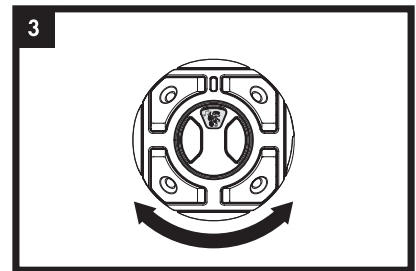
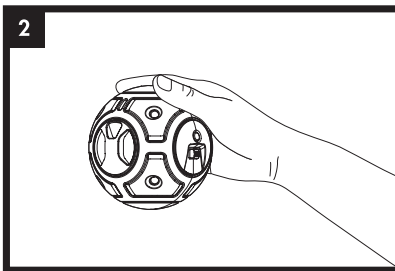
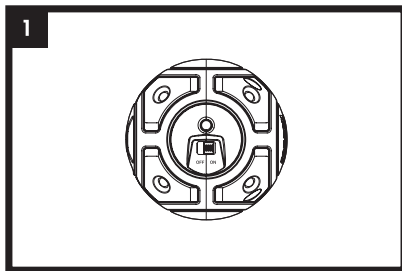

### DANCE (Blue)

Check out Miposaur™'s moves! Shake the ball to see Miposaur™ dance and play music! To stop dancing, shake the Trackball again.

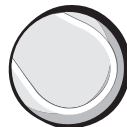

### BALL (Green)

Roll the Trackball along the ground and watch Miposaur™ chase and push the ball around!



### FOOD (Yellow)

Use the ball to feed Miposaur™ tasty treats!



### LEASH (Purple)

The Trackball becomes Miposaur™'s leash! Take it for a walk to lead Miposaur™ to new places to play and explore.



### TEDDY BEAR (Pink)

The Trackball becomes Miposaur™'s favorite toy!



### BEAT BOX (White)

When Miposaur™ gets close to the Trackball, it will start to beat box!

**Remember:** Miposaur™ will react to whether the Trackball is close to it, whether the Trackball is far away, when you shake the Trackball, or when you clap your hands. Experiment with Miposaur™ to see what the various reactions are!

**NOTE:** If Miposaur™ loses sight of the Trackball for more than a few seconds, or if the Trackball is turned off, it will change back to the Curious Mood. Also, after 5 minutes of inactivity, the Trackball will enter Sleep Mode. Shake the ball, turn the wheel, or power Off/On to awaken it.



# TRACKBALL AND APP

## Trackball - Interaction

You can interact with Miposaur™ via the Trackball in multiple ways:



## APP FUNCTIONALITY

### Apple® iOS and Android™ devices:

Devices must support Bluetooth® Low Energy (BLE) in order to play.

For the latest compatible device list, please visit [www.wowwee.com/devices](http://www.wowwee.com/devices)

Using the App, you can access a wider range of activities and games, including path tracing or having Miposaur™ dance to songs on your device.

**NOTE:** Miposaur™ will over-ride and reset any Moods or Items when connecting to the App.

### Downloading the App

#### For Apple® Devices:



Go to the App Store® and search for the Miposaur™ App. Then, click download.

#### For Android™ Devices:

Go to the Google Play™ Store or Amazon Appstore™ and search for the Miposaur™ App. Then, click download.

### Connecting to Miposaur™ with your device

#### To connect Miposaur™ with your device:

1. Turn Miposaur™ On as instructed in Getting Started (pg 7).
2. Open the Miposaur™ App on your device.
3. The App will bring up your Miposaur™'s ID in a list of available devices.
4. Follow the on-screen instructions to augment Miposaur™'s behavior, moods, and games.



## Q & A

**Q: My Miposaur™ won't show up in the app when I try to connect.**

A: Make sure your Miposaur™ has fresh batteries and is turned on, then close the app and switch Bluetooth® on/off in your device settings. If you are still having problems, try restarting your device completely.

**Q: My Miposaur™ disconnects often or is much slower than usual.**

A: This is most likely caused by interference. Ensure that there are no other Bluetooth® Low Energy (BLE) devices connected (especially audio devices), as these can cause interference which can cause issues. If you are still having problems, try turning Wi-Fi off to reduce interference.

**Q: When I try to download the Miposaur™ application onto my Android™ phone, it says it's incompatible with my device.**

A: Miposaur™ only works with devices which are Bluetooth® Low Energy (BLE) and running compatible operating systems. If you are still in doubt, check the compatibility list located on our website: <http://wowwee.com/devices>

**Q: I cannot access Google Play™ on my device, how can I download the application?**

A: Try downloading the application on the Amazon AppStore™ or other free app stores.

**Q: My Miposaur™ turns on, makes a noise then switches off.**

A: Most likely the batteries are low or flat. Try replacing the batteries in either Miposaur™ or the Trackball.

**Q: My Miposaur™ doesn't balance properly and keeps falling down.**

A: Most likely the batteries are low or flat, try replacing the batteries in Miposaur™.

**Q: My Miposaur™ will falsely detect gestures or cannot track the ball properly.**

A: Make sure that Miposaur™ is not being played with in strong sunlight or with other sources of infrared radiation, as these may cause issues with the sensors.



# WARRANTY

## WowWee® 90-Day Limited Warranty

WowWee's warranty obligations for Miposaur™ (this "Product") are limited to the terms set forth below.

WowWee Group Limited ("WowWee") warrants to the original end-user purchaser that this Product will be free from defects in materials and workmanship under normal use for a period of 90 days from the date of retail purchase (the "Warranty Period"). This warranty is extended only to the original end-user purchaser of a new product that was not sold "as is".

If a defect arises:

(1) you may within 30 days from the date of retail purchase (or such other period specified by the return policies of the place of purchase) return this Product to the place of purchase, together with the original proof of purchase and either the original box or the UPC code label from the box, and this Product will be replaced or, in the event that a replacement for this Product is not available at the place of purchase, either a refund of the purchase price for this Product or a store credit of equivalent retail value will be provided; or

(2) you may after the day that is 30 days from the date of retail purchase (or such other period specified by the return policies of the place of purchase) and within the Warranty Period contact WowWee Customer Support to arrange for the replacement of this Product. In the event that a replacement for this Product is not available this Product will be replaced by WowWee with a product of equivalent or greater retail value.

Notwithstanding the foregoing terms of this warranty, WowWee reserves the right at all times, at its sole option and discretion, to refund to you the purchase price paid by you for this Product in full and final settlement of WowWee's obligations under this warranty.

A purchase receipt or other proof of the date of retail purchase and purchase price is required in order to claim the benefit of this warranty.

If this Product is replaced, the replacement product becomes your property and the replaced Product becomes WowWee's property. If the place of purchase refunds the purchase price of this Product or issues a store credit of equivalent retail value, this Product must be returned to the place of purchase and becomes WowWee's property. If WowWee refunds the purchase price of this Product, this Product must be returned to WowWee and becomes WowWee's property.

### EXCLUSIONS AND LIMITATIONS

This warranty covers the normal and intended use of this Product. This warranty does not apply: (a) to damage caused by accident, abuse, unreasonable use, improper handling and care or other external causes not arising out of defects in materials or workmanship; (b) to damage caused by service performed by anyone who is not an authorized representative of WowWee; (c) to any hardware, software or other add-on components installed by the end-user; (d) if this Product has been disassembled or modified in any way; (e) to cosmetic damage, including but not limited to scratches, dents or broken plastic, or normal wear and tear.

THIS WARRANTY GIVES YOU SPECIFIC LEGAL RIGHTS AND YOU MIGHT ALSO HAVE OTHER RIGHTS THAT VARY FROM STATE TO STATE. WOWWEE'S RESPONSIBILITY FOR PRODUCT DEFECTS IS LIMITED TO THE REPLACEMENT OF THIS PRODUCT OR THE REFUND OF THE PURCHASE PRICE FOR THIS PRODUCT. ALL EXPRESS AND IMPLIED WARRANTIES, INCLUDING BUT NOT LIMITED TO ANY IMPLIED WARRANTIES AND CONDITIONS OF MERCHANTABILITY AND FITNESS FOR A PARTICULAR PURPOSE, ARE LIMITED IN TIME TO THE TERM OF THIS LIMITED WARRANTY. NO WARRANTIES, WHETHER EXPRESS OR IMPLIED, WILL APPLY AFTER THE EXPIRATION OF THE LIMITED WARRANTY PERIOD. If any term of this warranty is held to be illegal or unenforceable, the legality or enforceability of the remaining terms shall not be affected or impaired.

EXCEPT AS PROVIDED IN THIS WARRANTY AND TO THE EXTENT PERMITTED BY LAW, WOWWEE IS NOT RESPONSIBLE FOR DIRECT, SPECIAL, INCIDENTAL OR CONSEQUENTIAL DAMAGES HOWSOEVER CAUSED RESULTING FROM BREACH OF WARRANTY OR CONDITION OR UNDER ANY OTHER LEGAL THEORY, INCLUDING BUT NOT LIMITED TO LOSS OF USE. THE FOREGOING LIMITATION SHALL NOT APPLY TO DEATH OR PERSONAL INJURY CLAIMS, OR ANY STATUTORY LIABILITY FOR INTENTIONAL AND GROSS NEGLIGENT ACTS AND/OR OMISSIONS.

SOME STATES DO NOT ALLOW THE EXCLUSION OR LIMITATION OF INCIDENTAL OR CONSEQUENTIAL DAMAGES, OR LIMITATIONS ON HOW LONG AN IMPLIED WARRANTY LASTS, SO THESE LIMITATIONS MIGHT NOT APPLY TO YOU.

Valid only in U.S.A.

# MiPosaur™

## The Future of Prehistoric

Manufactured and distributed by © 2014 WowWee Group Limited. Product names, designations, and logos are trademarks or registered trademarks of WowWee Group Limited. All rights reserved.

Customer Service Website:  
<https://support.wowwee.com>

We recommend that you retain our address for future reference.

Product and colors may vary.

Packaging printed in China.

**WARNING!** This product is not suitable for children under 3 years because of small parts - choking hazard.

Apple, the Apple logo, iPhone, iPad, iPad mini, iPad Air, and iPod touch are trademarks of Apple Inc., registered in the U.S. and other countries. App Store is a service mark of Apple Inc., registered in the U.S. and other countries.

Android and Google Play are trademarks of Google Inc.

Amazon and Amazon Appstore are trademarks of Amazon.com, Inc.

MADE IN CHINA.

### CAUTION

Changes or modifications not expressly approved by the party responsible for compliance could void the user's authority to operate the equipment.



### NOTE

This equipment has been tested and found to comply with the limits for a class B digital device, pursuant to part 15 of the FCC rules. These limits are designed to provide reasonable protection against harmful interference in a residential installation. This equipment generates, uses and can radiate radio frequency energy and, if not installed and used in accordance with the instructions, may cause harmful interference to radio communications.

However, there is no guarantee that interference will not occur in a particular installation. If this equipment does cause harmful interference to radio or television reception, which can be determined by turning the equipment off and on, the user is encouraged to try and correct the interference by one or more of the following measures:

- Reorient or relocate the receiving antenna
- Increase the separation between the equipment and receiver
- Connect the equipment into an outlet on a circuit different from that to which the receiver is connected
- Consult the dealer or experienced radio/TV technician for help

This Device complies with Part 15 of the FCC Rules. Operation is subject to the following two conditions:

- (1) This device may not cause harmful interference, and
- (2) This device must accept any interference received, including interference that may cause undesired operation.

This device complies with Industry Canada Licence-exempt RSS-210.

Operation is subject to the following two conditions:

- (1) This device may not cause interference, and
- (2) This device must accept any interference, including interference that may cause undesired operation of the device.

For these purposes, the party responsible is:

WowWee USA Inc.  
7855 Fay Avenue  
Suite 310  
La Jolla CA, USA 92037  
1-800-310-3033

Frequency band(s) : 2,402 – 2,480 GHz

Maximum radio frequency power transmitted : -0,9 dBm

WowWee Group Limited declares that the product [MiPosaur™] is in compliance with Directive 2014/53/EU.

The full text of the EU declaration of conformity is available at the following internet address:

<http://www.wowwee.com/EUdeclaration.html>

**WARNING!** This equipment may experience difficulty and/or memory loss when subjected to any electrostatic discharge, radio frequency interference, or sudden power surge/interruption. The user is encouraged to reset the equipment should any of these occur.



WowWee Group Limited  
Energy Plaza, 301A-C  
92 Granville Road  
T.S.T. East, Hong Kong

WowWee Canada Inc.  
3700 Saint Patrick Street,  
Suite 206,  
Montreal, QC, H4E 1A2, Canada



0890US01SUN\_IML